

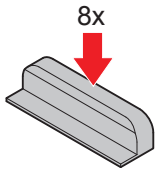

BANANAQUARIUM®
www.bananaaquarium.com/fg

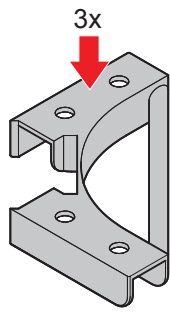

Use with:
6 mm glass

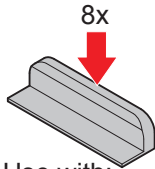
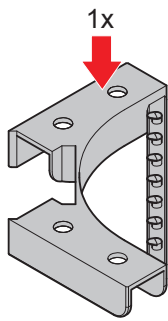

Use with:
8 mm glass

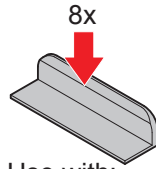
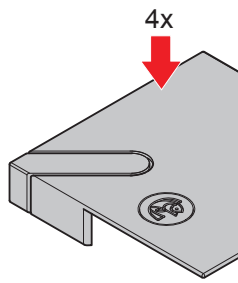

Use with:
10 mm glass

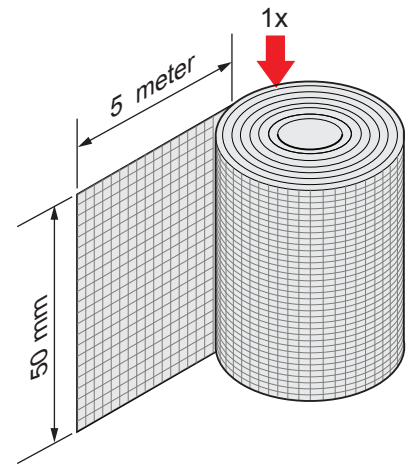

1

0 1 2

4x

Check

- 1 Measure glass thickness
- 2 Thickness less <12mm
- 3 Thickness more =12mm

2

Orient this way for bigger fish (from 7 cm)

Orient this way for smaller fish (up to 7 cm)

3

4

